

PUMPS A20 - AS20



INSTALLATION

OPERATION

MAINTENANCE

MOUVEX PERISTALTIC HOSE PUMP

SAFETY INSTRUCTIONS, STORAGE, INSTALLATION AND MAINTENANCE

MODELS : A20 - AS20

TECHNICAL CHARACTERISTICS

- Maximum pump speed acceptable* :
 - **90 tr/mn (rpm)**
- Maximum running temperature * :
 - **NR hose70°C (158°F)**
 - **NBR hose70°C (158°F)**
 - **EPDM hose80°C (176°F)**
- Maximum discharge pressure acceptable*:
 - **8 barg (116 psig)**
- Minimum suction pressure acceptable :
 - **-0,9 barg (-13 psig)**
- Cylinder capacity :
 - **0,138 dm³ (0,036 gallon)**

* CAUTION : Functional limitations indicated are strictly dependent on each other, refer to TECHNICAL DATA § to define the limits of use for your installation.

Pump n°:

Date of bringing into service :

SAFETY INFORMATIONS



This is a SAFETY ALERT SYMBOL

When you see this symbol on the product, or in the manual, look for one of the following signal words and be alert to the potential for personal injury, death or major property damage.



Warns of hazards that WILL cause serious personal injury, death or major property damage



Warns of hazards that CAN cause serious personal injury, death or major property damage.



Warns of hazards that CAN cause personal injury or property damage.

NOTICE

Indicates special instructions which are very important and must be followed.

NOTES

The numbers written in bold characters after part names correspond to reference numbers in the spare parts lists..

Photos and drawings used in this IOM are not contractual.

TABLE OF CONTENTS

Page

1. OVERALL DIMENSIONS	3
1.1 A20 model	3
1.2 AS20 model	4
2. INSTALLATION	5
2.1 Operator principle	5
2.2 Hose compression	5
2.3 Pumped liquid	5
2.4 Pipe diameters	5
2.5 Piping assembly	5
2.6 Direction of rotation	6
2.7 Liquids containing a high proportion of particles	6
2.8 Working with vacuum on the suction side	6
2.9 Handling	6
2.10 Pump location	6
2.11 Anchoring the pump units	6
2.12 Alignment of motor / pump and reduction gearbox / pump shafts	7
2.13 Electric motors	7
3. USE	8
3.1 Pump storage	8
3.2 Hose storage	8
3.3 Pumping hot products	8
3.4 Pump filled with product at shutdown	8
3.5 Starting-up the pump	8
3.6 Shutting down the pump	8
3.7 In the event of the hose breaking	8
3.8 Scrapping	8
4. MAINTENANCE OPERATIONS	9
4.1 Replacing the hose	9
4.2 Re-assembling and disassembling the wheel	12
5. TECHNICAL SPECIFICATIONS	13
5.1 Characteristics	13
6. MAINTENANCE	14
6.1 Lubrication	14
6.2 Hose	14
6.3 Seals	14
7. TROUBLESHOOTING	15
8. CERTIFICATE OF CONFORMITY	16

NOTES :

The MOUVEX peristaltic hose pumps **MUST** be installed on systems specially designed by qualified staff. Installation **MUST** comply with local standards, national rules and safety regulations.

This manual is designed for installation and start-up of the peristaltic hose pumps. It **MUST** be supplied with the pump.

Maintenance of the peristaltic pumps must be carried out **ONLY** by qualified personnel. This operation must comply with local and national regulations as well as safety standards.

Read the whole manual and all the instructions and precautions, **BEFORE** using any MOUVEX pumps.

Do not remove any warning and use stickers from the pumps.

1. OVERALL DIMENSIONS

1.1 A20 model

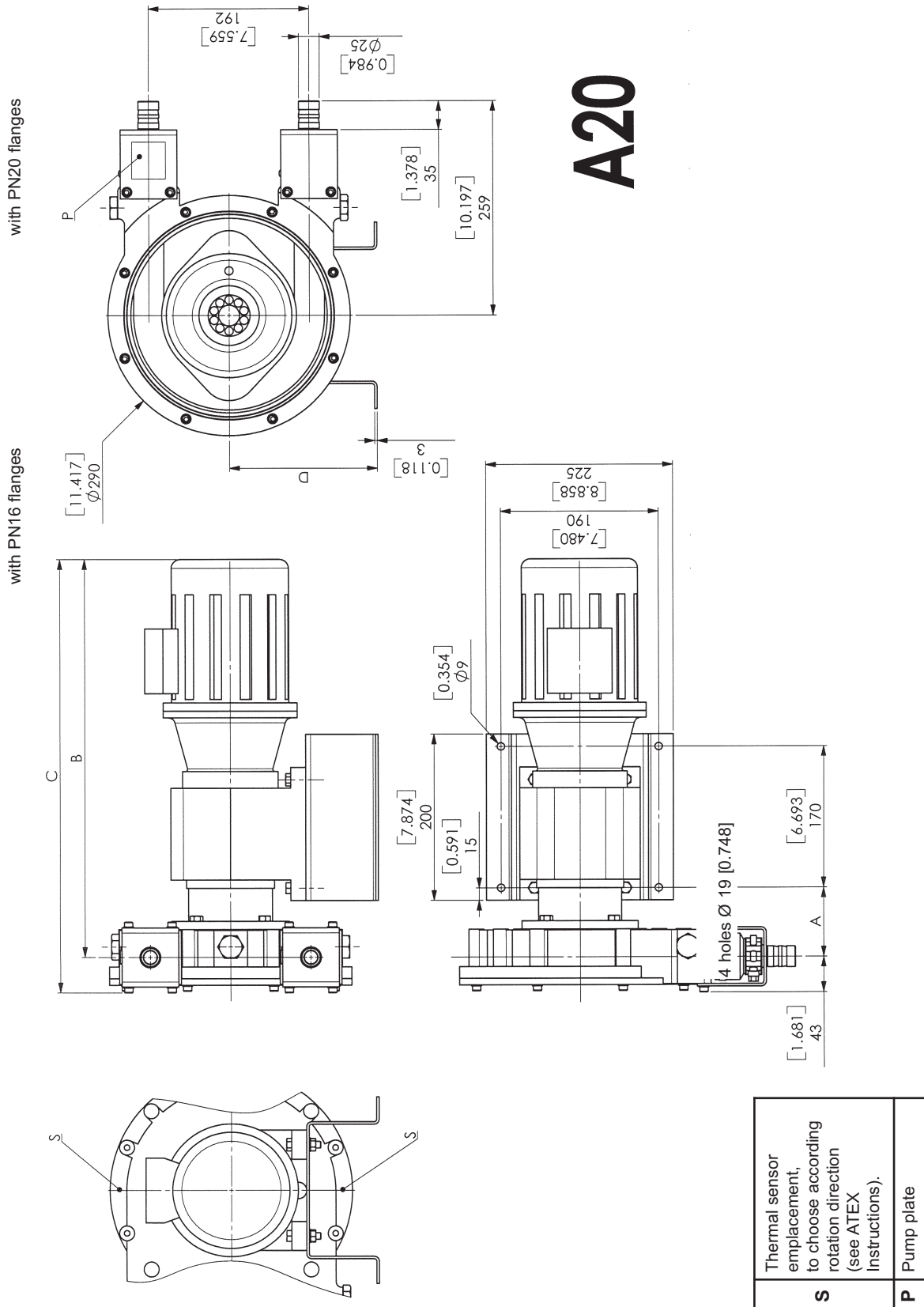

2. INSTALLATION

2.1 Operator principle

The pump operates by alternating contraction and relaxation of a specially designed elastomeric hose.

Two shoes attached 180° apart to a central wheel compress the hose against the pump body in a fluidtight manner.

Rotation of the wheel causes a flow by displacing the product into the hose.

The pump body is filled with a special lubricant allowing shoes to slide easily over the hose, which avoids overheating.

2.2 Hose compression

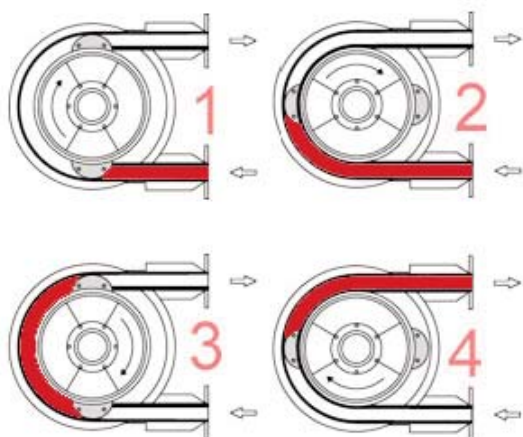

2.3 Pumped liquid

Under normal operation, the pumped liquid is only in contact with the hose and the inserts which must be compatible with it.

Three different quality elastomeric hoses are available :

- NR (natural rubber) White marking
- NBR (perbunan or buna) Yellow marking
- EPDM Red marking

Inserts are available in AISI 316 stainless steel, in polypropylene (PPH) and in polyfluoride vinylidene (PVDF).

This pumping technology is specially suited to handle abrasive products.

During the compression stage, abrasive particles may penetrate the hose wall without damaging it. Immediately after, these particles are released into the liquid (the size of particles does not however have to exceed 15 % of the internal diameter of the hose).

You can contact our Technical Services at any time to ask for the information you require.

2.4 Pipe diameters

The location of the pump in the transfer or recycling circuit should always be determined so as to reduce the suction height and length of the piping as much as possible.

The diameter of the pipes must be determined as a function of their length on the one hand, and the flow and viscosity of the product on the other, so that head loss remains within design limits. Therefore it is difficult to give general and precise directions.

However, we recall that it is never prejudicial to plan for wide piping diameters, particularly regarding the intake.

For the discharge, it is also possible to plan for a diameter equal to that of the pump's orifices, and on the intake, for a wider diameter if suction is very strong. In the case of viscous products, the determination of this diameter is very important since the variation of head loss is proportional to the viscosity and inversely proportional to the power of 4th of the diameter. Therefore a small reduction of piping diameter can have major consequences. Our Technical Services are always available to provide you with precise data if you give them accurate information or, better still, the installation plans.

2.5 Piping assembly

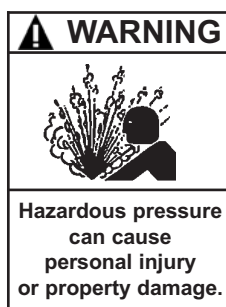

FAILURE TO RELIEVE THE SYSTEM PRESSURE PRIOR TO PERFORMING ANY WORK ON THE PUMP OR THE INSTALLATION CAN CAUSE PERSONAL INJURY OR PROPERTY DAMAGE.

Wherever possible, siphons and reverse slopes in the suction piping must be avoided and all the gaskets must be installed with great care to avoid air from entering the piping.

The elbows must always have a large radius and must not be assembled too close to the pump flanges, at the inlet as well as the outlet side.

The stresses exerted by the piping on the pump can deform the pump parts, increase wear, misalign the bearings and even cause parts to break.

The pipes must be designed to allow thermal expansion and contraction and be firmly secured (the use of flexible hoses and expansion loops is recommended).

We recommend placing isolating valves close to the pump flanges to permit dismantling and replacement without having to drain the installation. These valves should have the same diameter as the pipes and, by preference, be a full bore model.

2. INSTALLATION (continued)

If the liquid may freeze or solidify, prepare for draining the piping by installing drain taps at the low points and air vents at the high points.

In the case of a very high intake or if you wish to prevent the piping from emptying at shutdown, you can install a foot valve. It should have a large diameter so as not to generate additional head loss.

2.6 Direction of rotation



FAILURE TO RELIEVE THE SYSTEM PRESSURE PRIOR TO PERFORMING ANY WORK ON THE PUMP OR THE INSTALLATION CAN CAUSE PERSONAL INJURY OR PROPERTY DAMAGE.

The MOUVEX pump is reversible, this allows it to always circulate the liquid in the desired direction by choosing the corresponding direction of rotation.

The intake and discharge sides are determined as follows :

When an observer is placed on pump cover side (opposite to the shaft output), if rotation takes place clockwise, the intake is on the bottom, on the contrary if the rotation is anticlockwise, the intake is on the top.

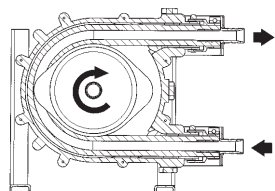

Clockwise rotation

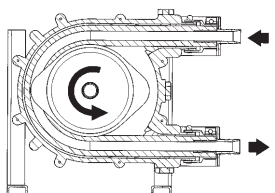

Anticlockwise rotation

2.7 Liquids containing a high proportion of particles

In the case where the pumped fluid contains particles, use the upper flange as the inlet flange.

This facilitates discharge of the sediments formed by the build-up of the particles contained in the fluid, so this reduces friction between the hose and the shoes.

Therefore, the pump may be re-started more easily.

2.8 Working with vacuum on the suction side

Because of the operating principle of the pump, using it with suction pressure lower than the atmospheric pressure will cause a resulting loss of flow more or less in line with the conditions of the application (hose material, rotation speed, temperature, etc.).

In order for the pump to generate the normally required flow, MOUVEX recommends using a vacuum draw kit inside the body of the pump.

In all cases, when using a vacuum kit, suction pressure must not be lower than -0,9 barg (-13 psig).

If a vacuum draw kit is not used on an ABAQUE pump operating with suction pressure lower than atmospheric pressure, MOUVEX no longer guarantees the performance of the pump.

2.9 Handling

The maximum weight of the pump is :

- A2044 kg (97 lb)
- AS2026 kg (57 lb)

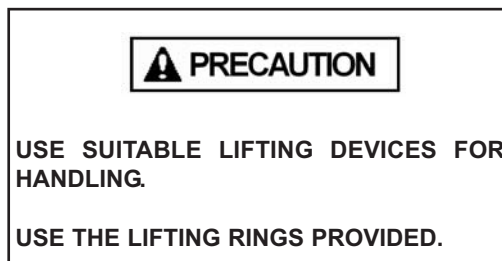

2.10 Pump location

Provide sufficient clearance around the pump for maintenance operations.

Particularly, make sure that there is sufficient clearance for replacing the hose; the distance between the pump flanges and the closest obstacle must allow the hose to be removed, as shown below :

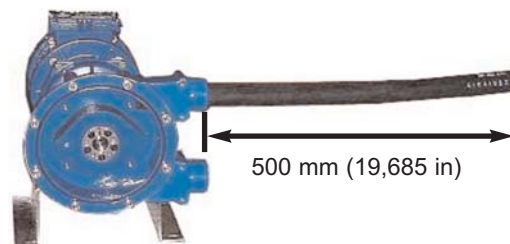

2.11 Anchoring the pump units

The correct seating of the pump is vital for its efficient operation and its longevity.

The surface must be resistant enough to absorb the stresses due to the pump unit without deformation.

In the case where the unit is fastened by anchor lugs or bolts, it must be carefully wedged to prevent any deformation of the chassis when tightening the bolts.

2. INSTALLATION (continued)

2.12 Alignment of motor / pump and reduction gearbox / pump shafts



OPERATION WITHOUT THE SHAFT PROTECTOR CAN CAUSE SERIOUS PERSONAL INJURY, MAJOR PROPERTY DAMAGE, OR DEATH.

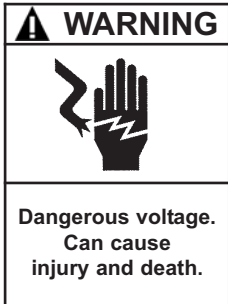

DISCONNECT THE ELECTRICITY SUPPLY BEFORE ANY MAINTENANCE OPERATION.

To check the alignment and coupling, use a set square to control the axial misalignment and feeler gauges for angular misalignment.

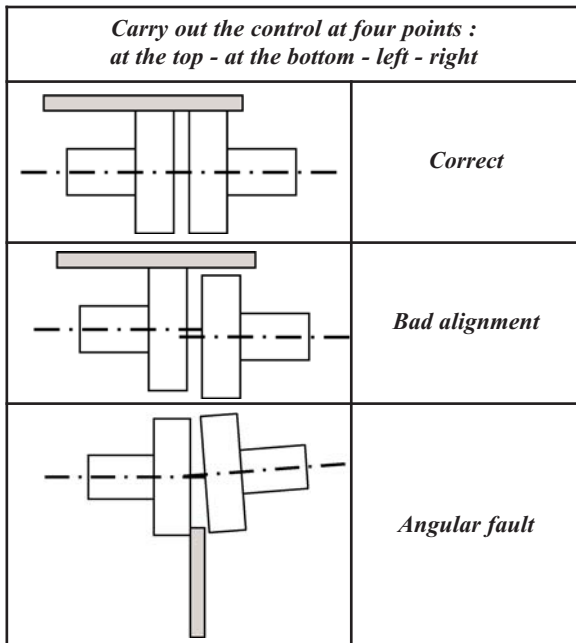

It is important to control the alignment at every step of installation in order to ensure that none of these steps generates stress on the pump unit or the pump itself :

- after fastening on foundations
- after fastening the piping
- after the pump has operated at normal operating temperature.

REMINDER :

Do not rely on the flexible coupling to compensate for misalignment.

2.13 Electric motors

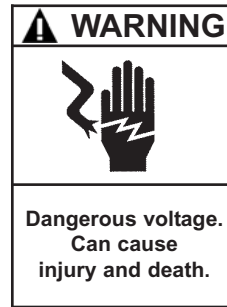

DISCONNECT THE ELECTRICITY SUPPLY BEFORE ANY MAINTENANCE OPERATION.

Check that the supply voltage matches the indications on the motor rating plate.

Comply with the wiring diagram, make sure the wires are rated for the power and take care with the contacts which must be thoroughly tightened.

The motors must be protected by appropriate circuit breakers and fuses.

Connect the regulatory ground connections.

Check the direction of rotation :



OPERATION WITHOUT THE SHAFT PROTECTOR CAN CAUSE SERIOUS PERSONAL INJURY, MAJOR PROPERTY DAMAGE, OR DEATH.

This fundamental checking of the pump must be done without any product, with the inlet and outlet circuit open to the air, for example, to avoid any risk of an unexpected pressure rise. Start the pump empty to check the correct operation of the connections and check that the direction of rotation corresponds to installation's inlet and outlet direction. Follow the instructions below if necessary to change the direction of rotation.

Three phase motor : switch any two wires of the current supply.

Two phase motor : switch the two wires of the same phase.

Single phase motor : comply with the instructions of the manual supplied with the motor.

3. USE

3.1 Pump storage

If the pump is inactive for more than 3 months, remove the hose.

If you do not wish to remove the hose, operate the pump for 5 minutes once a week.



NOTE :

Check that the wheel is always positioned so that a shoe is not in the lubricant and not against the hose.

For storage at temperatures below 0 °C (32 °F), specific precautions must be taken. Refer to § LUBRICATION.

3.2 Hose storage

Hose shelf life is limited to two years from the date of purchase.

The hoses must be stored in a cool place protected from light. Exposure to ultraviolet rays accelerates deterioration of the material, thus reducing shelf life.

3.3 Pumping hot products



THE SURFACES OF THE PUMP CAN BE AT A TEMPERATURE LIABLE TO CAUSE INJURY OR SEVERE DAMAGE.

When pumping products at high temperatures, take care when starting the pump for the first time, tighten the bolts to compensate for expansion effects.

3.4 Pump filled with product at shutdown

In the case where the pumping circuit is situated between isolating valves and/or has a check valve, you must bear in mind the variations in temperature that can occur, leading in particular to the expansion of the product in the circuit. In this case, provide a means of releasing the expansion volume. The use of a relief valve can suffice for this function. The opening pressure of this valve must be compatible with the pressure allowed by the parts composing the circuit.

With products including particles that settle at shutdown, it is necessary to ensure that the consistency of the deposited products will not affect the start-up of the pump.

3.5 Starting-up the pump

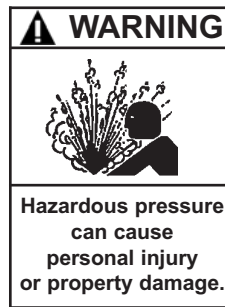

FAILURE TO RELIEVE THE SYSTEM PRESSURE PRIOR TO PERFORMING ANY WORK ON THE PUMP OR THE INSTALLATION CAN CAUSE PERSONAL INJURY OR PROPERTY DAMAGE.

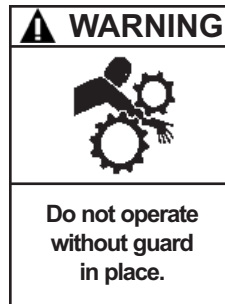

OPERATION WITHOUT THE SHAFT PROTECTOR CAN CAUSE SERIOUS PERSONAL INJURY, MAJOR PROPERTY DAMAGE, OR DEATH.

Before starting up the pump, always ensure that the pumping conditions are correct, with the corresponding valves open, especially the inlet valve.

For use at temperatures below 0 °C (32 °F), specific precautions must be taken. Refer to § LUBRICATION.

3.6 Shutting down the pump

When shutting down the pump, we recommend waiting for the pump to stop completely before closing the valves, especially the inlet valve.

3.7 In the event of the hose breaking



- THE CASING MAY BE FILLED WITH THE PUMPED FLUID.
- IF THE PUMP IS LOADED AT INTAKE OR DISCHARGE, ALL THE FLUID MAY BE EVACUATED THROUGH A HOLE IN THE HOSE IN THE PUMP BODY.

When the hose breaks, there is a risk that the lubricant may be contaminated by the pumped liquid.

3.8 Scrapping

The pump must be scrapped in compliance with the regulations in force.

During this operation, particular care must be paid to the drainage stages of the pump (pumped product).

4. MAINTENANCE OPERATIONS

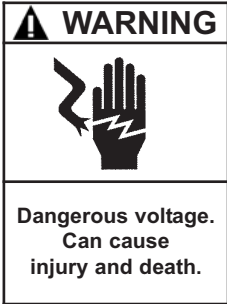

DISCONNECT THE ELECTRICITY SUPPLY BEFORE ANY MAINTENANCE OPERATION.

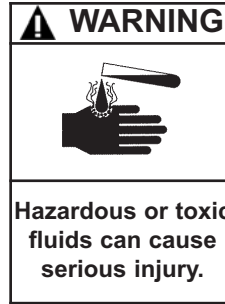

IF PUMPING HAZARDOUS OR TOXIC FLUIDS, THE SYSTEM MUST BE FLUSHED PRIOR TO PERFORMING ANY SERVICE OPERATION.



HANDLING THE PUMP WITHOUT THE COVER IN PLACE MAY CAUSE BODILY HARM, SERIOUS INJURY OR EVEN DEATH.

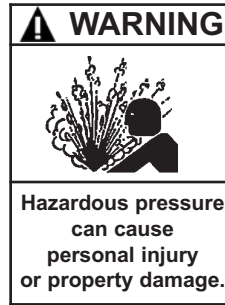

HYDRAULIC PRESSURE MUST BE FULLY RELEASED BEFORE MAINTENANCE OPERATIONS IN ORDER TO PREVENT PERSONAL INJURY OR PROPERTY DAMAGE.

4.1 Replacing the hose

4.1.1 DISASSEMBLING THE HOSE

Close the inlet and discharge valves, purge the pipes. Disconnect the pump from inlet and discharge piping.

NOTES

To insure an optimal life cycle of the hose, it is recommended to replace the worn lubricant by some new lubricant during any replacement of hose.

The hose may contain a certain volume of the pumped fluid, but this will be expelled when restarting the pump.

Evacuation of this fluid may also be carried out by running the pump after having taken all the safety measures required for personal and property protection.

If maintenance of the pump is not carried on site, check the wheel rotation direction to determine the inlet and discharge ends.

If the pump is equipped with the "leak detection kit", which allows the pump to be stopped in the event of the hose breaking, first the capacitive sensor must be removed by unscrewing the large PVC ring. See the kit Instructions for further information.

Drain the lubricant by unscrewing the level plug **33** and collect the lubricant in a tub.



Put the lubricant level plug **33** back in place.

Retighten cover screws **33** until they make contact.

Free the space as required and explained in § PUMP LOCATION.

Remove circlips **24** from the suction and discharge ports.

Loosen and remove screws **48** with their washers **49** and remove brackets **18** from the suction and discharge ports.



Loosen inlet and discharge clamps **7** and **9**.

Remove the 2 inserts **12**.



Place a tub under the lower port so that the lubricant in the pump is collected.

4. MAINTENANCE OPERATIONS (continued)

Remove clamps **7** and **9** in place and then hose boots **6**.

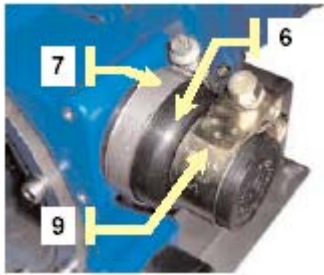

NOTE

If the pump is not re-assembled immediately, dry unpainted surfaces and coat them with the pump lubricant in order to protect them against corrosion.

After a visual inspection of the inside of the body and the wheel, lubricate all the internal parts of the casing with pump lubricant.

Assemble the cover **2** on the pump body **1** with screws **33** and washers **34**.

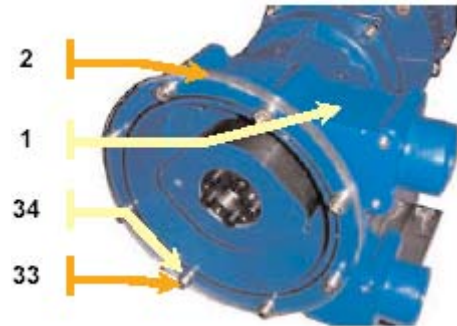

NOTE

Moderately tighten screws so as not to crack the transparent plate of the cover. Once the screws are tightened, the seal must be squeezed all over.

⚠ WARNING



THE HOSE CAN BE EXPELLED VIOLENTLY. BE SURE NO ONE IS IN FRONT OF PUMP PORTS.

Hazardous machinery can cause severe personal injury or property damage.

Operate the pump intermittently until the hose is completely out.

⚠ WARNING



DISCONNECT THE ELECTRICITY SUPPLY BEFORE ANY MAINTENANCE OPERATION.

Dangerous voltage. Can cause injury and death.

Disassemble cover **2** after removing screws **33** and washers **34**.

Wash the inside of the pump body and the cover with water or a cleaning product that is compatible with the pump materials. Also wash the wheel (front + back).

NOTES

If the pump is not re-assembled immediately, dry unpainted surfaces and coat them with the pump lubricant in order to protect them against corrosion.

Dispose of the drained products in accordance with the rules and regulations in force.

4.1.2 REASSEMBLING THE HOSE

If this operation has not yet been carried out, remove cover **2**, screws **33** and washers **34**.

Wash the inside of the pump body and the cover with water or a cleaning product that is compatible with the pump materials. Also wash the wheel (front + back).

⚠ WARNING



NEVER INSERT THE HOSE OR RUN THE PUMP WITHOUT ITS COVER AND ITS WINDOW IN PLACE.

Do not operate without guard in place.

4. MAINTENANCE OPERATIONS (continued)

Clean the hose **16** to eliminate any particles that may have adhered to it (gravel, etc.) and generously coat it with lubricant.



Insert the loose end of the hose **16** in the inlet port of the pump body **1**.

Operate the motor intermittently until the hose **16** is completely inserted in the body so that the same length protrudes from both ports of the body.

⚠ WARNING



DO NOT STAND IN FRONT OF THE OUTLET AXIS OF THE HOSE TO PREVENT BEING HIT BY THE HOSE.

The weight of the parts can be dangerous and may provoke bodily injuries or material damages.

⚠ WARNING



DO NOT USE YOUR HANDS TO PLACE THE HOSE INTO THE PUMP.

Do not operate without guard in place.

INLET FLANGE :

After coating it with lubricant, slide the hose boot **6** on the inlet side over the hose **16** and the pump body **1**.



Fit clamps **7** and **9** without tightening them.

Coat the outside of insert **12** with the lubricant, then fit it in the pipe until the shoulder is in contact with the pipe end.



Fit bracket **18** on insert **12** and screw it on the body using screws **48** and washers **49**.

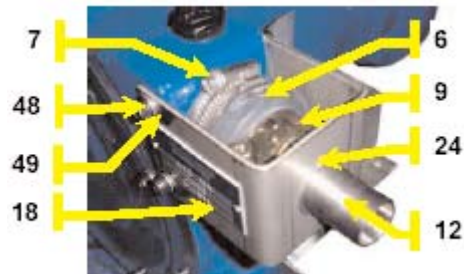

Fit snap ring **24** in the groove provided for this purpose on the insert.

Appropriately tighten clamp **7** on hose boot **6**. Make sure that it is not cut **7** (take care on the direction of assembly of the hose clamp : it must be directed so that the part presenting a lively fish bone is side body).

Tighten hose clamp **9** onto nipple **6** and hose **16** (the screw should be tightened to the stop).

When starting the pump, check that there is no leakage between the pump body **1** and the nipple **6**. Tight again the hose clamp **7** if needed.

DISCHARGE FLANGE :

Repeat the previous operations on the discharge side.

4. MAINTENANCE OPERATIONS (continued)

FILLING WITH LUBRICANT :

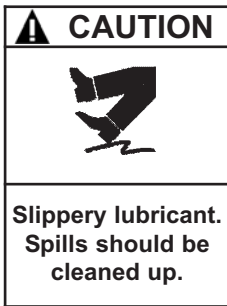

THE PUMP LUBRICANT IS VERY SLIPPERY AND MAY CAUSE SERIOUS INJURY. ANY SPILLS MUST BE CLEANED UP.

Loosen plug **11** and plug **23** located at the top of the body.

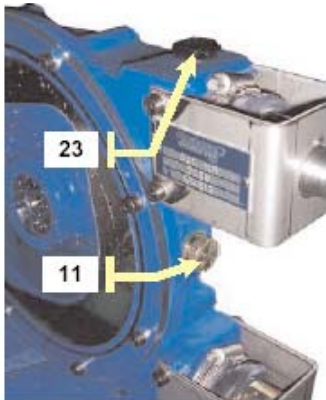

Fill the pump body with lubricant (see § LUBRICATION).

Tighten plugs **11** and **23** in the body.

NOTES

Handle the lubricant with care.

Wear suitable clothes and protect yourself from pump lubricant spatters.

Run the pump for a few minutes to check correct operation.

Reinstall the inlet and discharge piping.

Put the leak detection kit back in place, if the pump is equipped with one.

In the event that the breathing vent has been removed, check the installation direction for the existing back flow valve (the valve must allow air out and block it from entering).

4.2 Re-assembling and disassembling the wheel

Disassembly and reassembly of the wheel **3** are required when :

- Replacing the shaft seal **26**.
- Performing a complete overhaul.
- Disassembling or replacing the bearing box or the reduction gear.

For disassembly the wheel **3**, the pump hose must be removed (see § REPLACING THE HOSE).

4.2.1 DISASSEMBLING THE WHEEL

Loosen screws **19a** in the hub **19**.

Tighten one of the screws **19a** into the tapped hole of the hub **19** provided to pull out the cone.

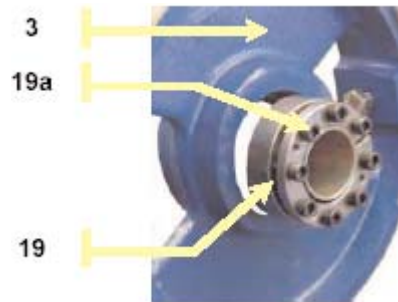

Remove the wheel **3** by sliding it along the central axis.

4.2.2 ASSEMBLING THE WHEEL

Check the shaft seal **26**. Replace when necessary, making sure that it is assembled so that the spring can be seen inside the pump body.

Check that the wheel have no dents or deep scratches that may quickly deteriorate the hose.

Insert the parts of the hub **19** in the wheel center.

NOTES

Screws **19a** must not be tightened so the wheel assembly can freely slide along the axis.

The flat side of the wheel **3** must be positioned on the front side of the pump as well as the screws **19a** of the expansible hub.

Slide wheel **3** with its hub **19** on the axis.

Align wheel **3** with pump body **1** while keeping setting distance as indicated on the following diagram :

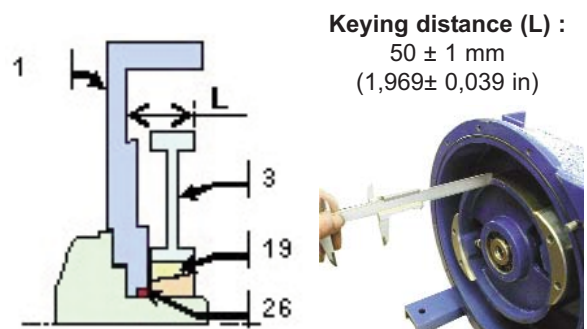

After checking that the expansible hub is properly centered with regard to the wheel thickness, gradually tighten screws **19a** while keeping wheel alignment correct.

5. TECHNICAL SPECIFICATIONS

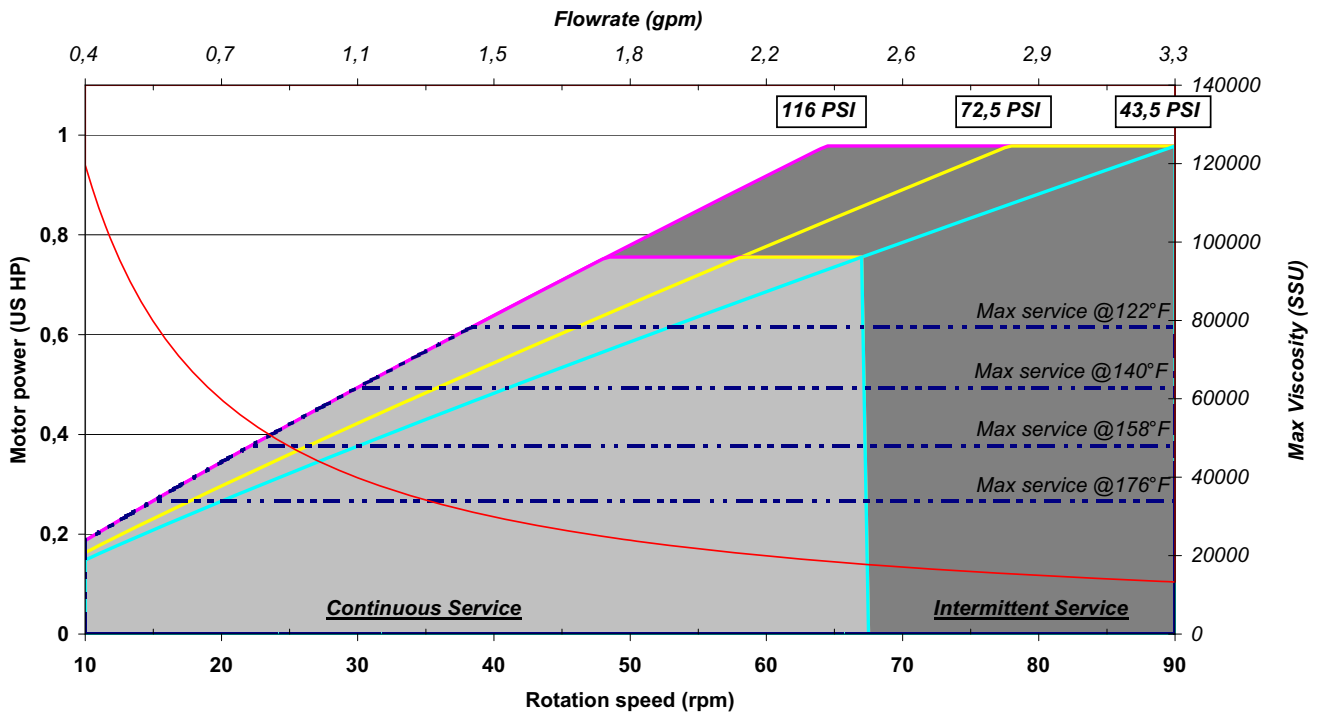
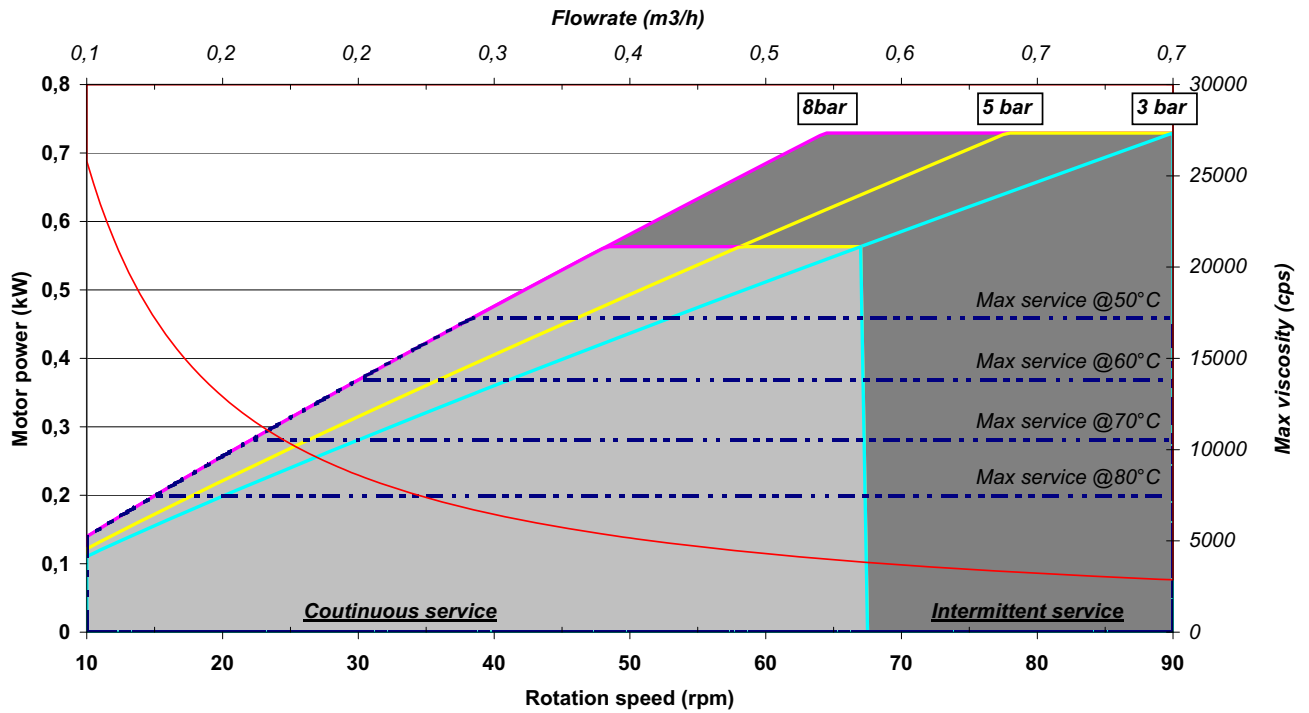

 **ATEX certified Abaque pumps have specific limits for use. Refer to corresponding Instructions Manual for more informations.**

5.1 Characteristics

Light grey area : Continuous service (24h/24).

Dark grey area : Intermittent service (continually for 2 hours then stopped for 1 hour).

The flow rates shown have been obtained by pumping water at room temperature.

Above the limit of Max service at 50°C (122°F), the maximum temperature of liquid is 40°C (104°F).

6. MAINTENANCE

6.1 Lubrication

The hose is lubricated with a special mixture. MOUVEX lubricant is recommended to lengthen the service life of the hose.

It is recommended to change the lubricant when :

- Replacing the hose.
- Replacing the hose due to maintenance operation.
- After 2000 hours of operation.

Amount of lubricant required :

A20 and AS20 pumps require 0,6 liter of lubricant.

The minimum working or storage temperature for the pump lubricant is 0°C (32°F).

For use / storage at lower ambient temperatures, it is necessary to add ethylene glycol to the MOUVEX lubricant. To maintain optimum lubrication, the volume of ethylene glycol should remain between 4% and 6% of the total volume of lubricant, and the total quantity of lubricant present in the pump must be in compliance with the value specified above.

In any case, the ambient temperature should never be lower than -20°C (-4°F).

6.2 Hose

Some pumped liquids require the hose to be cleaned after each operation to prevent solidification of the fluid inside the hose.

The hose can be easily washed with a cleaning agent that is compatible with the hose material and the pumped product.

It is recommended that the hose be monitored so that it can be replaced before any breakdown should occur. Preventive replacement is advisable.

Temperature threshold values for the liquid pumped depend directly on the materials that make up the hose.

Refer to technical characteristics on the cover page for the corresponding values.

It is important to note that the temperature of the pumped liquid influences the limits of use of the pump and that a rise of the temperature of the pumped liquid has to come along with a modification of the service pressure / of the speed of rotation so as to respect the limits defined in § TECHNICAL SPECIFICATIONS.

When required, you can contact our Technical Services at any time to ask for the information you require.

6.3 Seals

6.3.1 SHAFT SEAL 26

The shaft seal **26** must be replaced if lubricant leakage is observed near the drip strip, located on the rear side of the pump body **1**.



6.3.2 COVER SEAL 10

The cover seal **10** must be checked when removing the cover **2** and replaced if necessary (see § DISASSEMBLING THE COVER).

7. TROUBLESHOOTING

PROBLEM	POSSIBLE CAUSE	SOLUTION
THE PUMP WILL NOT START	Electric power supply failure.	Check the connections : <ul style="list-style-type: none"> • There must be 3 phases • The connections are suitable for the voltage (delta-star) • If possible, check the parameters for the different motor frequencies (starting torque, power input...)
	When the pump has not been used for a long period of time, the boss of the wheel has not been dipped in the lubricant. As it has not been lubricated, it causes a lot of resistance on start up.	Operate the pump intermittently to try to free the wheel but do not be too insistent to prevent the reduction gear from being damaged. If the wheel remains stuck, contact your local dealer for instructions.
	Sediments or other substances have built up inside the hose and are blocking the pump.	Reverse the pump rotation direction or disassemble the hose. If the wheel remains stuck, contact your local dealer for instructions.
WEAK FLOW	The inlet or discharge valve is partially closed.	Open the inlet or discharge valve.
	Air is entering the inlet piping.	Check the inlet line.
	The pumped liquid is too viscous. Significant pressure drop at inlet.	Check the inlet line (see § 2.4 PIPE DIAMETERS).
	The pump hose is damaged.	Replace the hose (see § 4.1 REPLACING THE HOSE).
TEMPERATURE TOO HIGH	The lubricant is not suitable.	Empty the pump body and replace the lubricant with one that is recommended by MOUVEX.
	The lubricant is dirty or too old.	Empty the pump body and replace the lubricant with a new MOUVEX lubricant.
	Temperature of the pumped fluid is too high.	Check the maximum fluid temperature allowed for the hose material.
	Pump speed too high.	Reduce speed.
HOSE LIFE TOO SHORT	Lubricant is not suitable.	Empty the pump body and replace the lubricant with one that is recommended by MOUVEX.
	Chemical incompatibility between the hose and the pumped fluid.	Check the compatibility of the hose with the fluid and replace the hose with another one made of suitable material.
	Temperature of pumped fluid too high.	Check the maximum temperature permitted for the hose.
	The discharge pressure is too high.	Check the maximum pressure allowed for the pump. Reduce pressure drop at discharge.
	Pump speed is too high.	Reduce speed.
THE HOSE IS PULLED INTO THE PUMP BODY AT INLET	The pumped fluid contains impurities or sediments.	Reverse the pump rotation direction and use the upper port for inlet.
	Clamp 9 is not sufficiently tightened.	Retighten the clamp.

8. CERTIFICATE OF CONFORMITY



CERTIFICATE OF CONFORMITY CE

Mouvex, ZI La Plaine des Isles – Rue des Caillottes – 89 000 Auxerre France, declares the following equipment:

Set-up : Pump / Compressor « bare-shaft » Pumping Unit / Compressor Unit
Type : Eccentric Disc Pump Vanes Pump Lobes Pump
 Peristaltic Pump Centrifugal Pump Other Pump
 Screws compressor Vanes compressors Hydraulic cooler

Designation: _____ s/n°: _____

According to the specifications recorded in the file N°: _____

And with the following marking:  IIB G c IIB-T4 Max T° Flow = 80°C

Is in conformity with the provisions of the following Directive:

- « **MACHINES** » Directive 2006/42/EEC as transposed by the national legislation, concerning safety equipments and arrangements relative to mechanical and electric risks applicable to rotative machines.

NF EN 809:2009 NF EN 1672-2:2009 NF EN ISO 13857:2008 NF EN 12162:2009

- « **ATEX** » Directive 94/9/EC (23 march 1994) as transposed by the national legislation, concerning equipment intended to be used in explosive atmospheres. Conformity obtained by application of the standards :

NF EN 1127-1:1997 NF EN 13463-1:2009 NF EN 13463-5:2009

ATEX Certification delivered by INERIS, Notified Body (INERIS - Parc Technologique Alata – 60550 Verneuil-en-Halatte - France).

The equipment indicated above must be used according to the foreseen use by its design and its manufacturing, and according to the current standards.

We, undersigned, declare that the concerned equipment is in conformity with the Directives listed above and in the applicable standards in force.

For Mouvex SAS Company.

Date: _____

Quality Manager

MOUVEX sas : Z.I La Plaine des Isles – 2, rue des Caillottes - 89000 AUXERRE – France – SAS au capital de 8 496 855 €
Tél : (33) 3.86.49.86.30 – Fax : (33) 3.86.46.42.10 – RCS AUXERRE 389 236 548 – APE 291 B – FR 85 389 236 548 – www.mouvex.com