

CHARACTERISTICS

		STANDARD	AVAILABLE OPTIONS
Technology		Peristaltic	
Maximum Flow rate at 1 cSt L/h (GPM)		9600 (42.26) (1)	
Ports		ISO PN16 flanges	ISO PN20 / ANSI150 flanges
Dimensions mm (in.)	A	1050 (41.34)	
	B	616 (24.25)	
	C	430 (16.93)	
	D	110 (4.33)	
	E	707 (27.83)	
Weight kg (lbs)		130 (287)	

(1) Intermittent duty only.

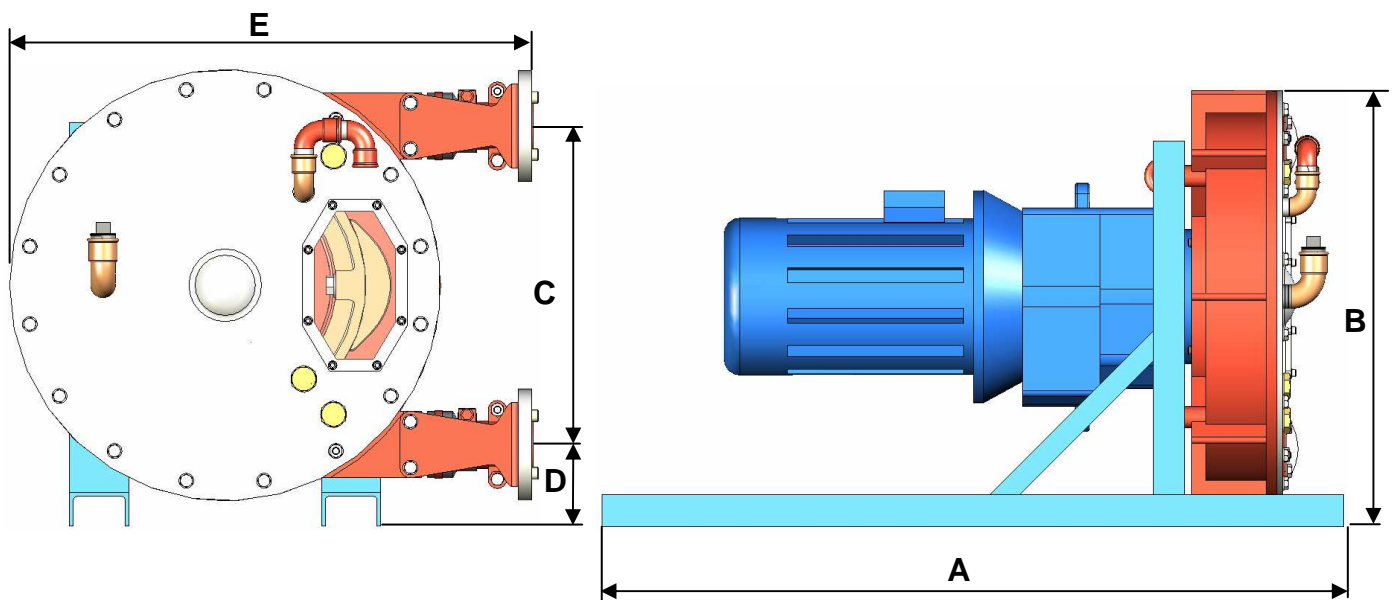

OPERATING LIMITS

	STANDARD MATERIALS	OPTIONAL MATERIALS
Minimum temperature °C (°F)	0 (32)	
Maximum temperature °C (°F)	70 (158)	80 (176) with EPDM hose
Maximum viscosity cSt (SSU)	23000 (107000)	
Maximum differential pressure bar (psi)	15 (217)	
Maximum speed rpm	120 (1)	
Maximum solid particle size mm (in)	6 (0.23)	
Maximum soft particle size mm (in)	10 (0.39)	

(1) Intermittent duty only.

MATERIALS OF CONSTRUCTION

Part No	PART NAME	STANDARD MATERIALS	AVAILABLE OPTIONS
1	Casing	Ductile Iron	
2	Cover	Carbon steel	
3	Wheel	Ductile Iron	
5	Shoe	Aluminum	Cast iron
6	Boot	EPDM	
10	Cover seal	FKM	
26	Lip seal	FKM	
12	Insert	316L Stainless steel	PPH, PVDF
16	Hose	NR	NBR, EPDM
18	Bracket	316L stainless steel	
21	Frame	Carbon steel	
	Bolts, screws, washers	316L stainless steel	
25	Window	Polycarbonate	

